

SL60

2-3nm+ Solar Marine Lantern

This equipment complies with requirements of the U.S. Coast Guard in 33 CFR part 66



Shown with optional 200mm OD base pattern (SL60-LB)

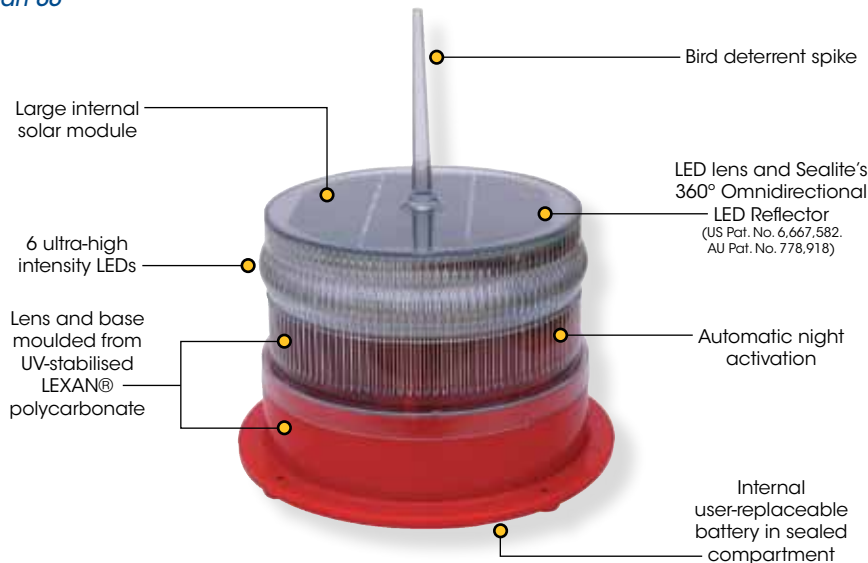

The Sealite Advantage

- 256 IALA flash patterns, user-adjustable without the need for external devices
- User-replaceable battery in sealed battery compartment
- NiMH battery for long service life & wide temperature range
- 4 user-adjustable intensity settings
- ON/OFF storage switch
- IP68 waterproof

The Sealite SL60 is the world's most popular and versatile 2-3nm+ solar marine light.

Made from tough, durable polycarbonate and using the latest high intensity LEDs, no expense has been spared in the design and development of this lantern.

The SL60 can be installed in minutes, and requires no operator intervention. The flash characters are easily adjusted onsite by the user, and the lantern has a permanent ON/OFF switch for easy storage.

During daylight hours the solar module will charge the battery and the lantern will automatically begin operation at dusk – once the ambient light threshold drops sufficiently.

The sealed battery compartment allows the battery to be replaced after years of service – don't throw the light away at the end of the battery service life.

Optional 200mm OD Base Pattern

The SL60 is available with optional large 200mm OD base pattern to suit installation requirements.

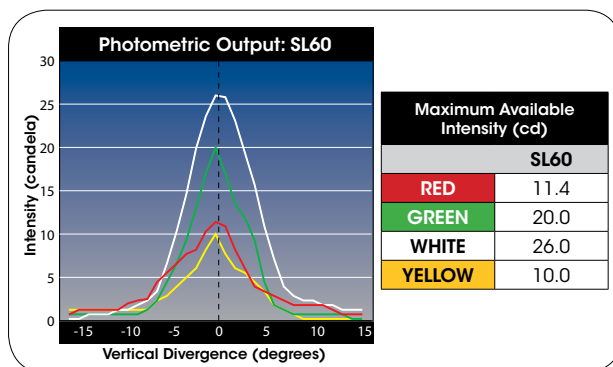

SL60

2-3nm+ Solar Marine Lantern



User-replaceable battery

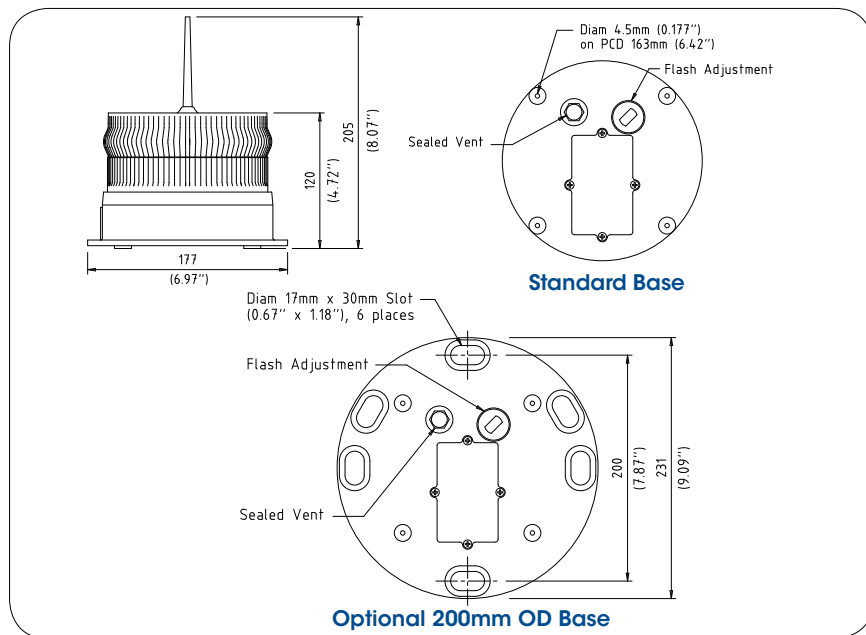

SPECIFICATIONS •



Sochi, Russia



Cadiz, South of Spain

Light Characteristics

Light Source 6 ultra-high intensity LEDs
 Available Colours Red, Green, White, Yellow, Blue
 Maximum Available Intensity (cd)† Red - 11.4 Green - 20.0 White - 26.0 Yellow - 10.0
 Visible Range (nm) 2-3+
 Horizontal Output (degrees) 360
 Vertical Divergence (degrees) 9
 Reflector Type Omnidirectional 360° LED Reflector (US Pat. No. 6,667,582. AU Pat. No. 778,918)

Available Flash Characteristics

Intensity Adjustments Up to 256 IALA recommended (user adjustable)
 LED Life Expectancy (hours) Adjustable in 25% increments
 >100,000

Electrical Characteristics

Current Draw (mA) Refer to Sealite Power Calculator
 Circuit Protection Integrated
 Nominal Voltage (v) 3.6
 Autonomy (days) >20 (14 hour darkness, 12.5% duty cycle)
 Temperature Range -40 to 80°C

Solar Characteristics

Solar Module Type Multicrystalline
 Output (watts) 1.4
 Solar Module Efficiency (%) 14
 Charging Regulation Microprocessor controlled

Power Supply

Battery Type High grade NIMH - Environmentally friendly
 Battery Capacity (Ah) 4
 Nominal Voltage (v) 3.6
 Battery Service Life Average 5 years

Physical Characteristics

Body Material LEXAN® Polycarbonate - UV-stabilised
 Lens Material LEXAN® Polycarbonate - UV-stabilised
 Lens Diameter (mm/inches) 150 / 5 7/8
 Lens Design External optics with interior flute design
 Mounting 4 x 4.5mm mounting holes
 Height (mm/inches) 205 / 8 1/8
 Width (mm/inches) 177 / 7
 Mass (kg/lbs) 0.9 / 2 1/8 (SL60-LB 1 / 2 1/4. SL60/8Ah 1 / 2 1/4. SL60-LB/Ah 1.1 / 2 1/2. SL60-LB/16Ah 1.5 / 3 1/3)
 Product Life Expectancy Up to 12 years

Certifications

CE EN61000-6-3:1997. EN61000-6-1:1997
 Quality Assurance ISO9001:2008
 Waterproof IP68

Intellectual Property

Patents US Pat. No. 6,667,582. AU Pat. No. 778,918
 Trademarks SEALITE® is a registered trademark of Sealite Pty Ltd
 3 years

Warranty *

Options Available

- 8Ah battery
- 16Ah battery
- 200mm OD base
- 50mm pole mount adapter plate

• Specifications subject to change or variation without notice
 * Subject to standard terms and conditions
 † Intensity setting subject to solar availability

